

NIPPON MARU PAPER MODEL 「にっぽん丸」ペーパークラフト NO.1 [各コース共通]

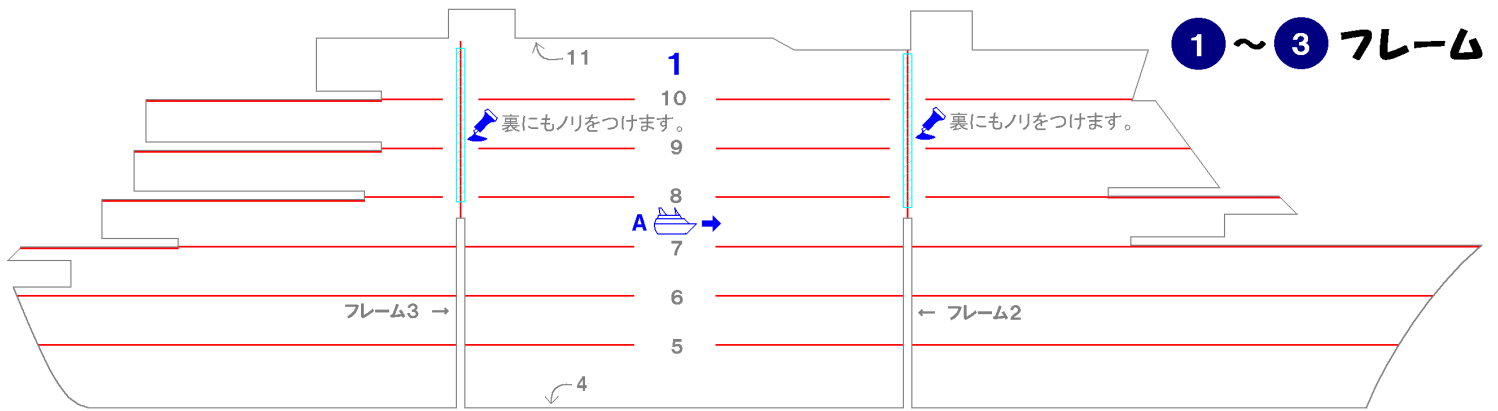

① ~ ③ フレーム

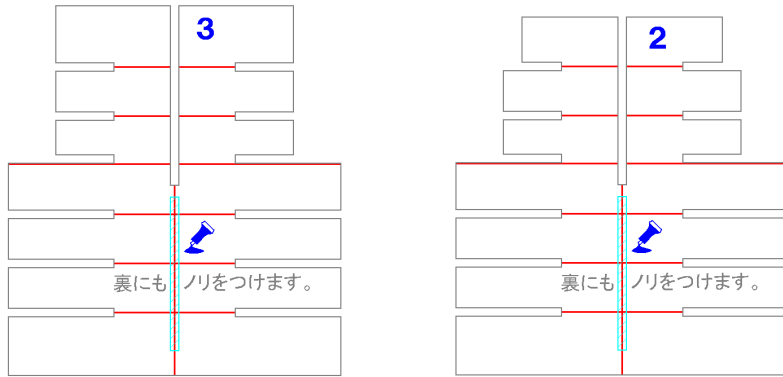

④ ~ ⑥ デッキ

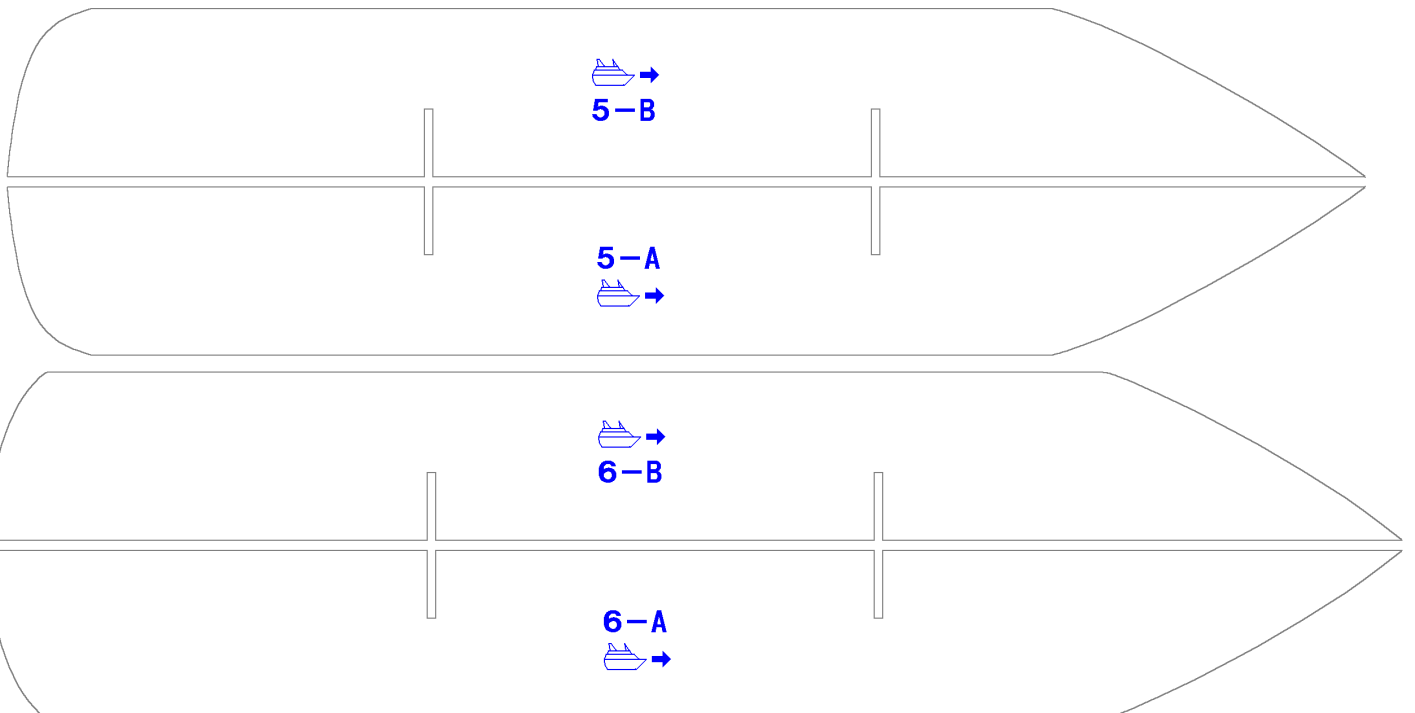

7 ~ 10 テッキ

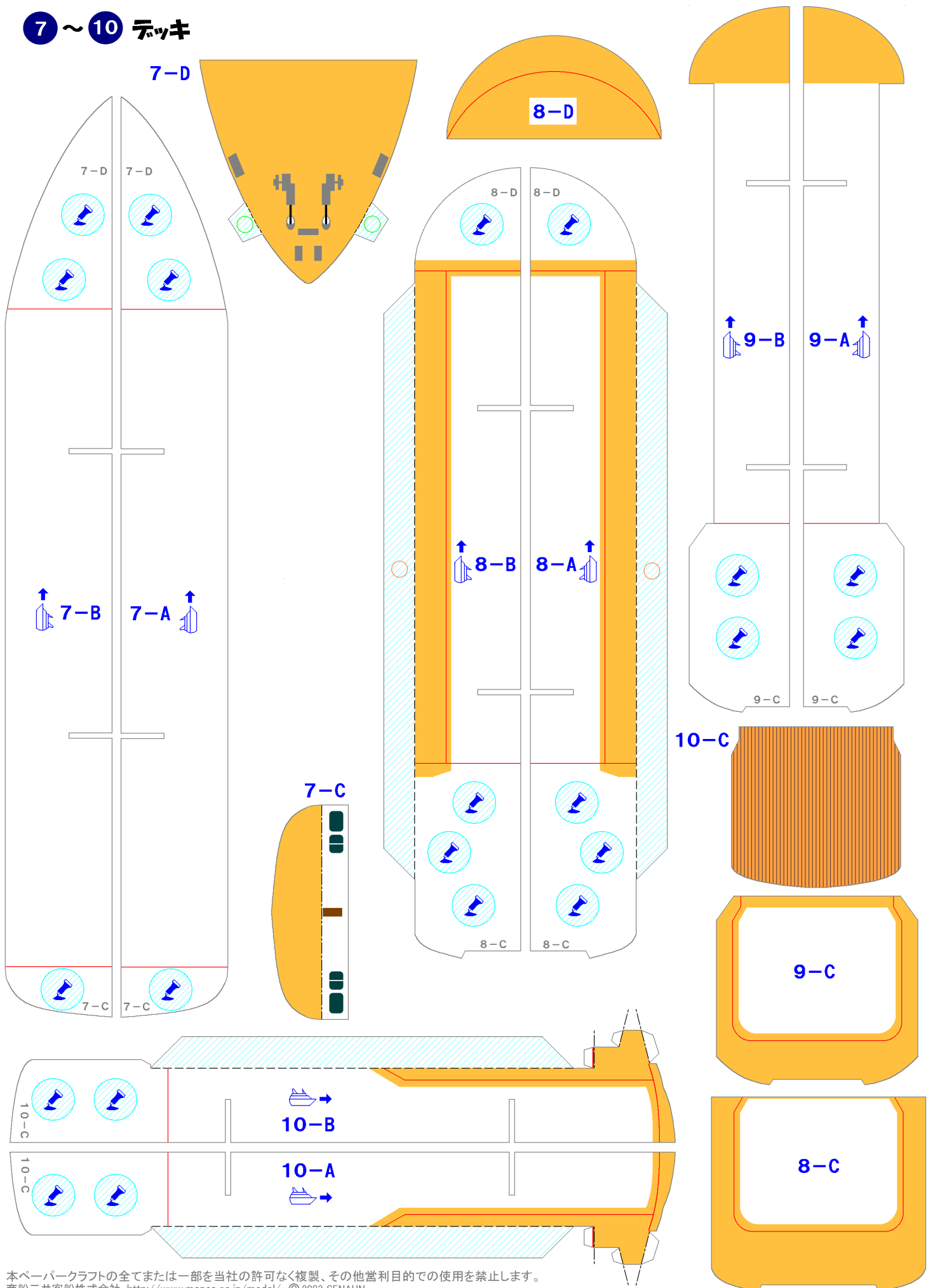

23・24 フリッジ(操舵室)

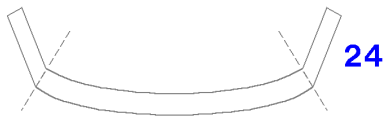

赤い印のある方が下側です。

17～19 レーダーマスト

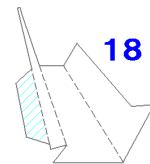
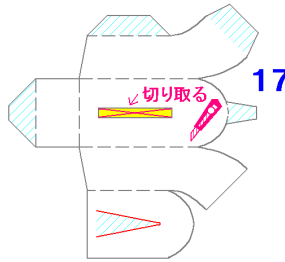

16・22 サンデッキ

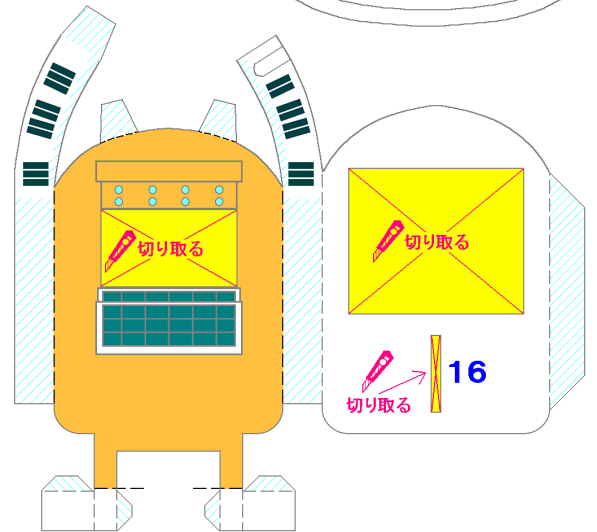

11 テッキ

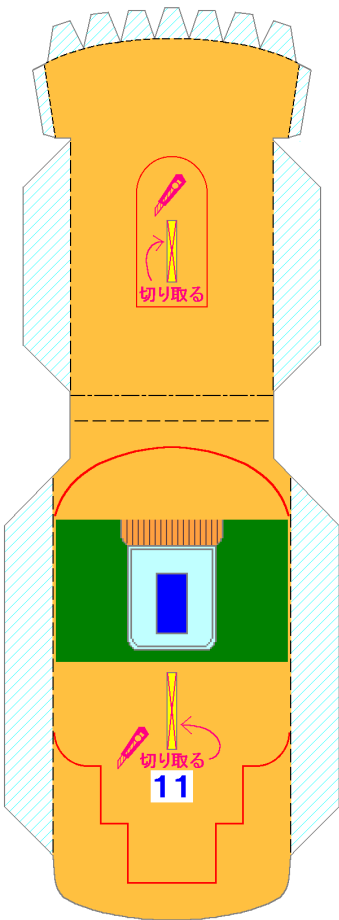

20・21・25～27 船体

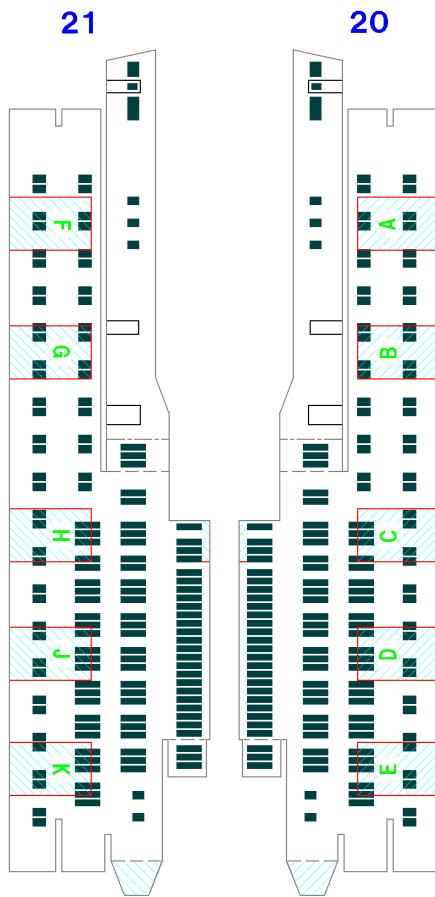

12～15 ファンネル(煙突)

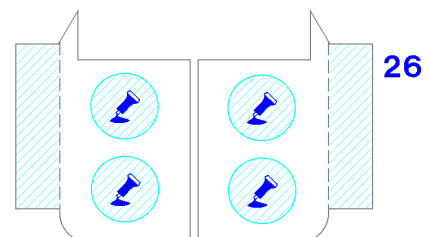
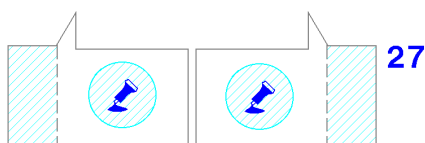
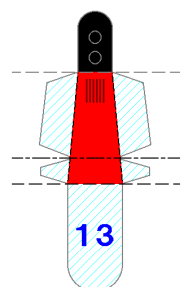
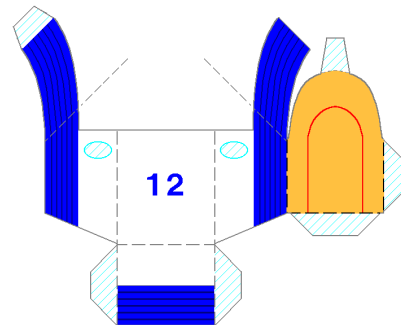
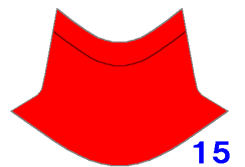

28 ~ 33 船体

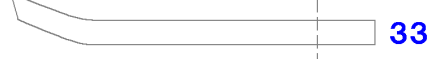
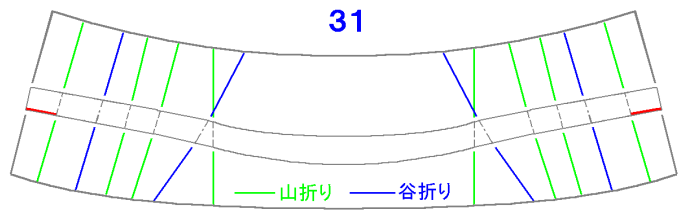
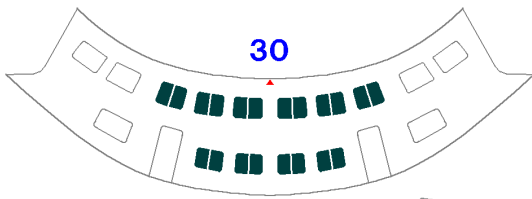
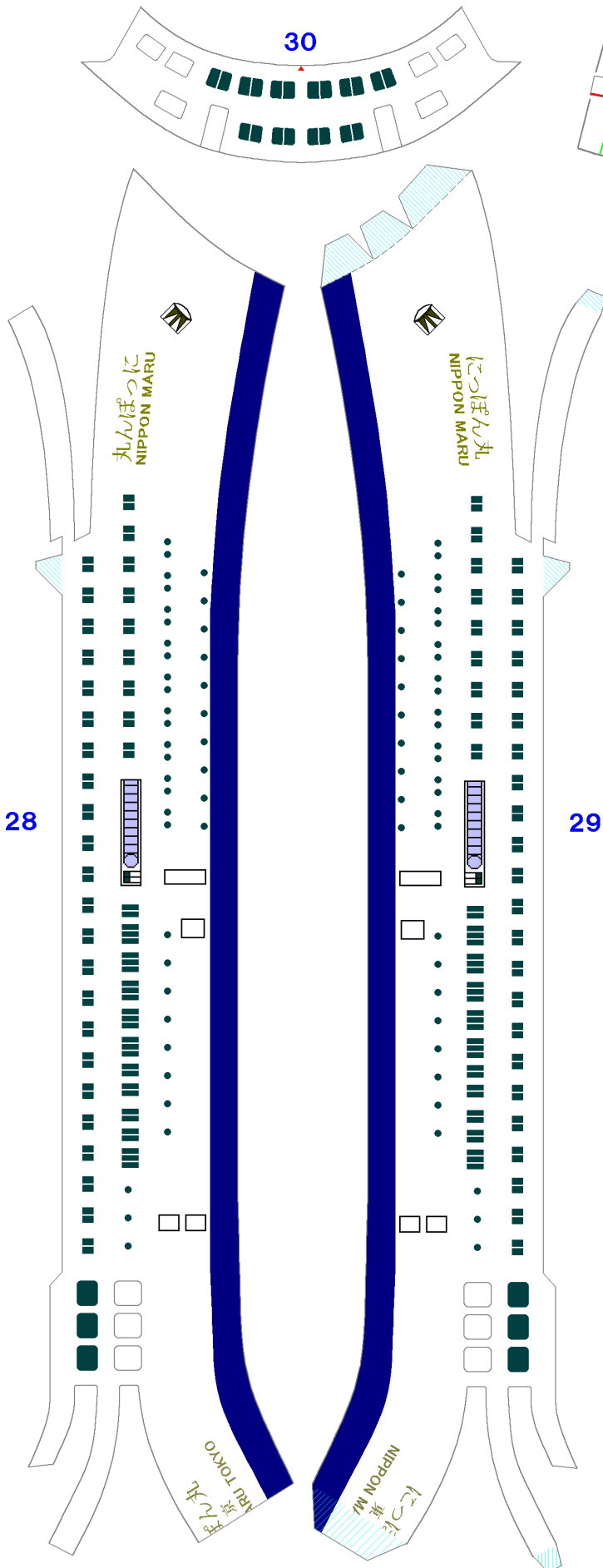

34 ・ 36 救命ボート

35 ・ 37 デンターボート

